



Bulletin: Building Sanitary Sewer Connections

Purpose

To inform building contractors and the public of the specifications and Standards required for Building Sanitary Sewer Connections.

The following drawings are simplified in this document; however, any discrepancies shall be superseded by the [BC Plumbing Code](#) , [Sewer Regulation Bylaw 1486](#) and [Subdivision Servicing Bylaw 1956 Consolidated](#) .

Getting Started

The District of Peachland has prepared this guide for your convenience to assist you with your sewer service hookup. You will be required to:

- Select a qualified plumber or sewage excavating contractor.
 - Apply to the District of Peachland for a sewer connection.
[Water, Water Meter, and/or Sewer Service Application](#)
- Plan your connection carefully. You will not be able to use your plumbing system during the installation and testing of the service connection or prior to final utility inspection.
 - [Peachland Sewer Service Construction Guide](#)
- The **Building/Utilities** inspector must inspect and verify the test for your new system to ensure long term reliability.
- It is very important that you coordinate with your contractor and the building inspector and call for required inspections.
- Ensure the proper connection is made. No roof drainage or storm drainage of any kind is allowed to be connected into the municipal sanitary sewer system.

Connection to the gravity line:

The following criteria must be adhered to when applying for a sanitary sewer connection:

- **Complete a sewer service application** and determine the location & depth of the municipal service connection stub or existing inspection chamber outside the property line.
- **Pipes and connections must abide by the BC Building or Plumbing Code.** Please reference [Table A-2.2.5, 2.2.6. and 2.2.7. Summary of Pipe and Fitting Applications](#) to view materials permitted for sanitary sewer use.
- **Please reference [BCPC Division B - Section 2.2. Materials and Equipment](#)** for information pertinent to plumbing systems.
- All piping and fittings must be certified to the Standards in the **BC Plumbing Code**.



Bulletin: Building Sanitary Sewer Connections

- All piping must be installed according to the requirements of the most current B.C. Plumbing Code. This includes a water test with a 3.0m (10ft) head from grade to top of the vertical section of the test pipe
- The sewer pipe must be installed with a minimum grade of 2% on 100mm (4") pipe or 1.0% where 150mm (6") pipe in the direction of flow and must be fully surrounded by a minimum of 100mm (4") of bedding sand.
- Sewer pipe shall have a minimum frost cover of at least 600mm (24") of soil and a minimum cover of at least 1.2 m (48") of soil under driving surfaces or as required by the District of Peachland Building Inspector.
- Where a portion of the home can be drained by gravity then a gravity system shall be installed. Only those levels that must be pumped shall be pumped. ****An engineered system will be required for a pumped system.**
- Your plumber must install a cleanout at the point where the building sewer leaves the building. Additional cleanouts must be installed at every change in direction of 45 degrees or a cumulative distance of 26m (85ft).
- The District installed an inspection chamber outside the property line when the sewer system was constructed. Make your connection to this municipal inspection chamber. The purpose for this inspection chamber is to facilitate the cleaning of the service connection on municipal property.
- Sewerage sump pumping systems shall be designed to accommodate the expected flows and pressures. ****An engineered system will be required for a pumped system.**
- Trenches exceeding 1.22m (4ft) in depth must be shored to the requirements of the **WorkSafe BC**. Contractors or employees of the District of Peachland will not enter a trench that is deemed to be unsafe.
- Your plumber must prepare as-built drawings and submit them to the building inspector at the time of the inspection.

Septic System Decommissioning (If necessary):

When a service connection is made where a septic system exists, the septic system must be decommissioned. Septic tanks shall NOT be connected to the sanitary sewer system.

- The sludge or deposits in a septic tank may not enter the sanitary sewer system and must be pumped and hauled away.
- Arrange to have the existing septic tank pumped by a licensed septic disposal contractor. **Documentation as proof of completion will be required (receipts, photos, reports, etc.) shall be provided to the Inspector at the time of inspection.**
- The septic tanks shall be fully disconnected, then be filled with fresh earth, gravel, or sand, or may be broken down and removed from the property.



Bulletin: Building Sanitary Sewer Connections

- Remove the septic tank or make a hole at the bottom of the tank and fill the tank completely with sand or other materials allowed per the bylaw. The Municipal sewage system is designed to accept raw sewage only directly from your house.

[Sewer User Regulation Bylaw 1486, Consolidated](#)

Plumbing Code References

2.4.6.4. Protection from Backflow

- 1) Except as permitted in Sentence (2), a backwater valve or a gate valve that would prevent the free circulation of air shall not be installed in a building drain or in a building sewer. (See Note A-2.4.6.4.(1).)
- 2) A backwater valve is permitted to be installed in a building drain provided that
 - a) it is a “normally open” design conforming to
 - i) CSA B70, “Cast Iron Soil Pipe, Fittings, and Means of Joining,”
 - ii) CAN/CSA-B181.1, “Acrylonitrile-Butadiene-Styrene (ABS) Drain, Waste, and Vent Pipe and Pipe Fittings,”
 - iii) CAN/CSA-B181.2, “Polyvinylchloride (PVC) and Chlorinated Polyvinylchloride (CPVC) Drain, Waste, and Vent Pipe and Pipe Fittings,” or
 - iv) CAN/CSA-B182.1, “Plastic Drain and Sewer Pipe and Pipe Fittings,” and
 - b) it does not serve more than one dwelling unit.
- 3) Except as provided in Sentences (4) to (6), where a building drain or a branch may be subject to backflow, a gate valve or a backwater valve shall be installed on every fixture drain connected to them when the fixture is located below the level of the adjoining street.
- 4) Where the fixture is a floor drain, a removable screw cap is permitted to be installed on the upstream side of the trap.
- 5) Where more than one fixture is located on a storey and all are connected to the same branch, the gate valve or backwater valve is permitted to be installed on the branch.
- 6) A subsoil drainage pipe that drains into a sanitary drainage system that is subject to surcharge shall be connected in such a manner that sewage cannot back up into the subsoil drainage pipe. (See Note A-2.4.6.4.(6).)

2.4.6.5. Mobile Home Sewer Service

- 1) A building sewer intended to serve a mobile home shall be
 - a) not less than 4 inches in size,
 - b) terminated above ground,
 - c) provided with
 - i) a tamperproof terminal connection that is capable of being repeatedly connected, disconnected, and sealed,
 - ii) a protective concrete pad, and
 - iii) a means to protect it from frost heave, and
 - d) designed and constructed in accordance with good engineering practice.

Bulletin: Building Sanitary Sewer Connections

A-2.4.6.4.(6) Protection from Backflow Caused by Surge. These requirements are intended to apply when in the opinion of the authority having jurisdiction there is danger of backup from a public sewer.

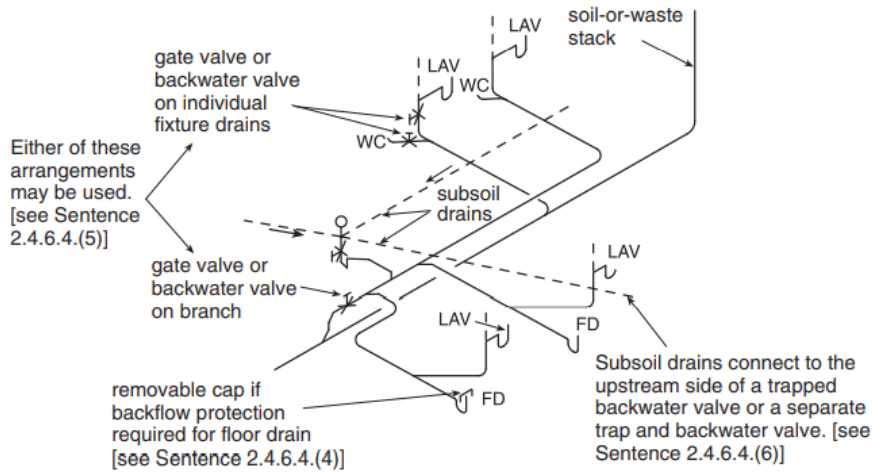

EG01149B-1

Figure A-2.4.6.4.(6)
Protection from Backflow Caused by Surge

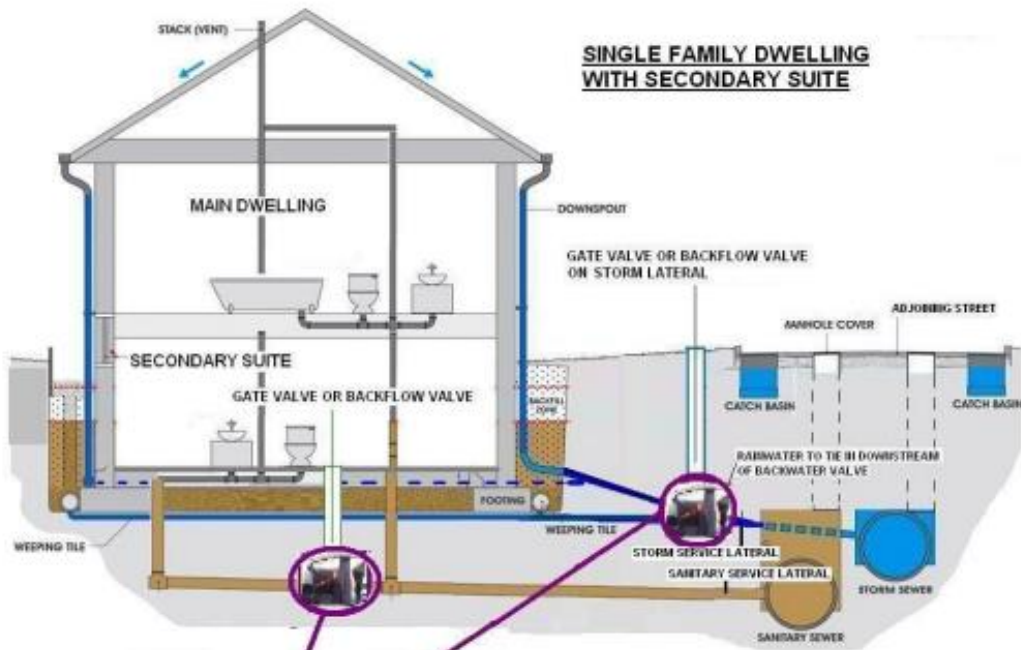

LOCATION OF MAIN BACKWATER VALVE STORM SYSTEM AND SANITARY SYSTEM

2018 BC BUILDING CODE
2.4.6.4. PROTECTION FROM BACKFLOW

SUBSOIL DRAINS CONNECT TO UPSTREAM SIDE OF BACKWATER VALVE



NORMALLY OPEN BACKWATER VALVE

Bulletin: Building Sanitary Sewer Connections

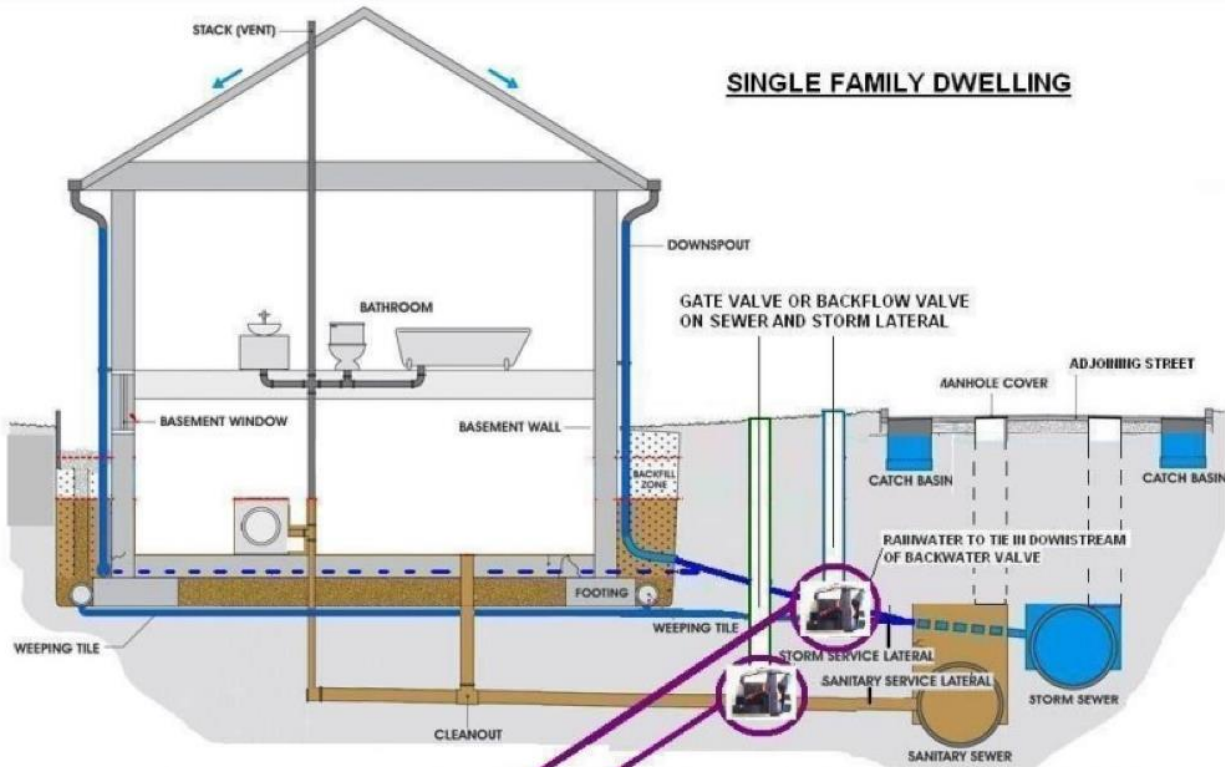

LOCATION OF MAIN BACKWATER VALVE STORM SYSTEM AND SANITARY SYSTEM

2018 BC BUILDING CODE 2.4.6.4. PROTECTION FROM BACKFLOW

2.4.6.4.(3) A building drain or a branch may be subject to backflow. A gate valve shall be installed on every fixture drain connected to them when the fixture is located below the level of the adjoining street.



NORMALLY OPEN BACKWATER VALVE



Bulletin: Building Sanitary Sewer Connections

Who do I call if I have a Question?

Building Sewer System Connections on the Private Property side:

Call the **Building Inspector** at 250-767-3709 or email Building Department .

Sewer System Connections on the Public side:

If you have any questions or concerns, please contact the Public Works Office at 250-767-2108 or email: operations@peachland.ca .

Sewer information can be found at: [Sewer Information](#)

Application: [Water & Sewer Service Application](#)

What do I do if I Experience Sewage Backup?

Have your plumber remove the lid to the inspection chamber and see whether there is any sewage flow observed, then the blockage must be between the inspection chamber and the home and is the property owner's responsibility. If the inspection chamber is filled with effluent, contact District of Peachland Operations Dept./Public Works at 250-767-2108. Or email: operations@peachland.ca .

General Notes:

All pipes must be CSA approved.

- 2% minimum slope on 100mm (4") pipe
- 1% minimum slope of 150mm (6") pipe
- All trenches must be backfilled so that the sewer pipe is surrounded in a minimum of 150mm (6") of bedding sand.
- Fill in a sewer service application and submit with the Building Application
- Hire your own contractor to complete the works
- Contact the Building/Utilities Inspector for an inspection prior to tying into the Public sanitary sewer system.

*****An engineered system will be required for a pumped system.***

Bulletin: Building Sanitary Sewer Connections

Building Sanitary Sewer Service Sample Drawings:

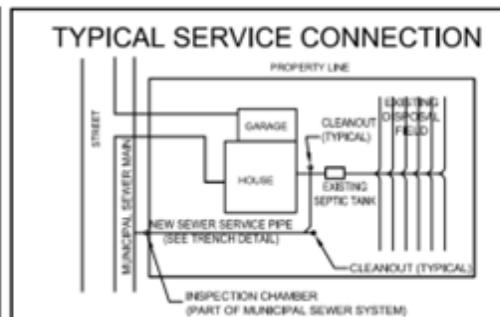
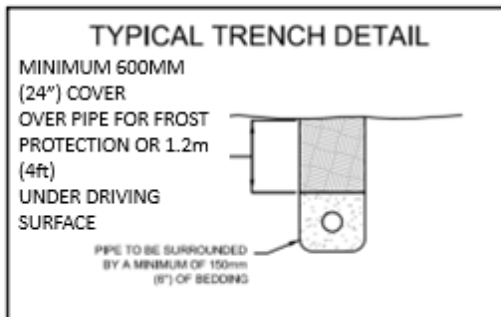
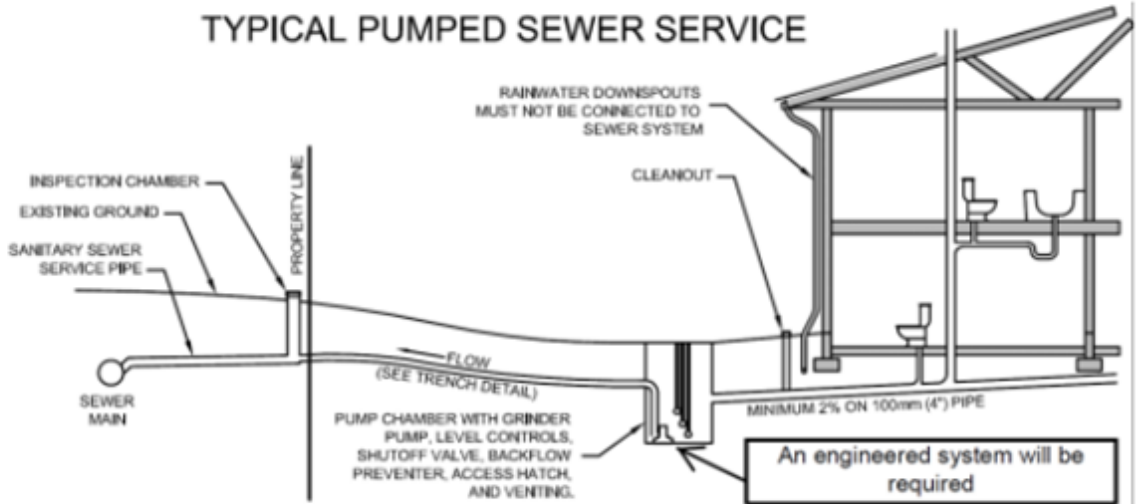
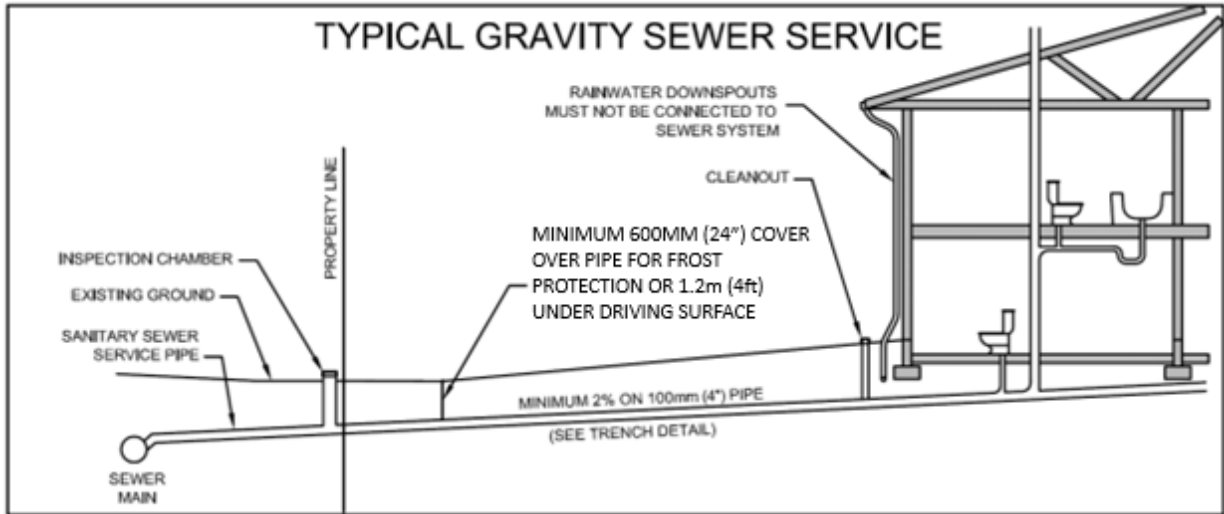

Bulletin: Building Sanitary Sewer Connections

Municipal Sanitary Sewer Service Connection Drawing Sample from MMCD: <https://www.peachland.ca/sewer>

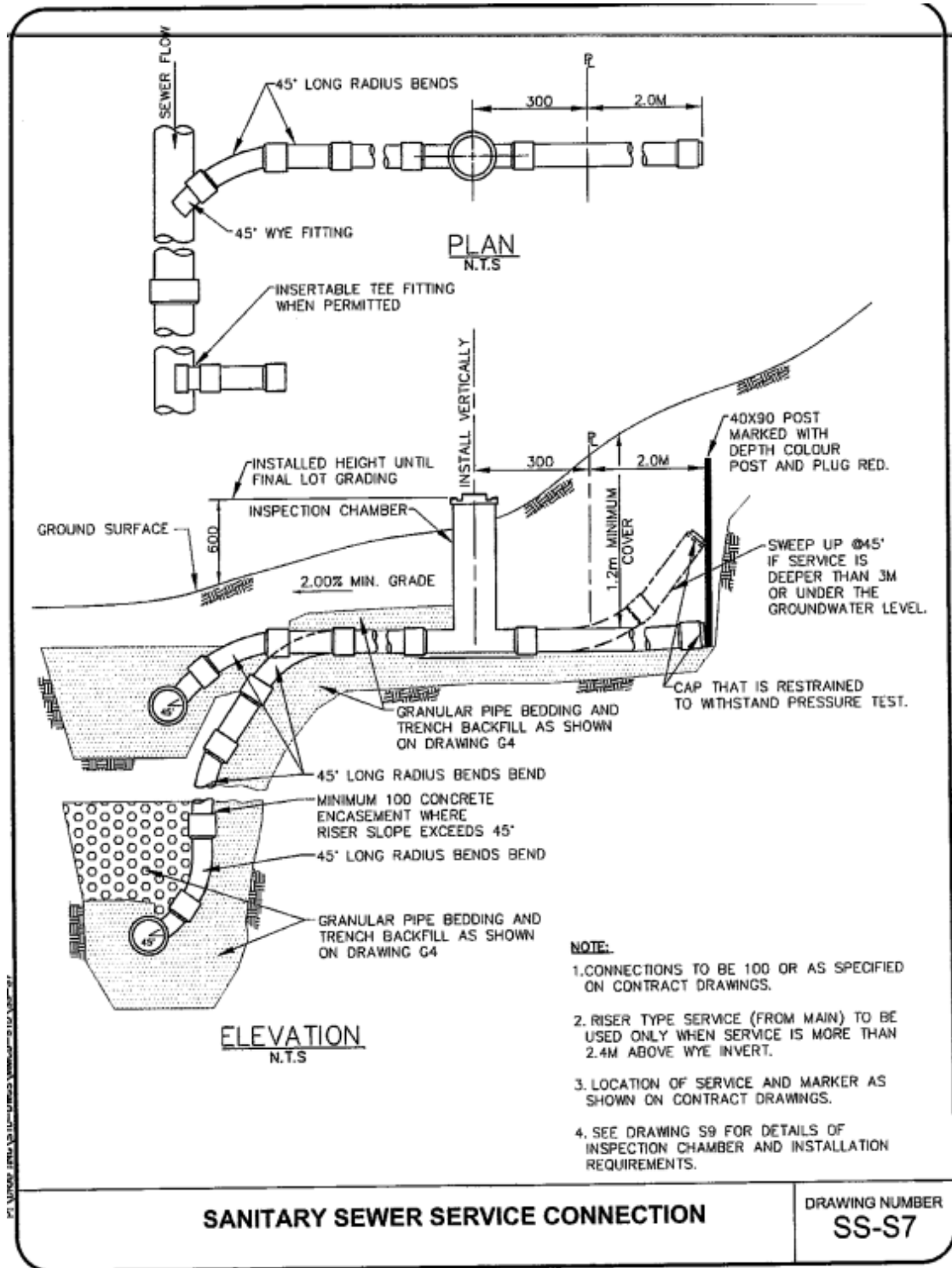



Bulletin: Building Sanitary Sewer Connections

References

[BC Plumbing Code](#)

[BC Building Code](#)

[Building Bylaw](#)

[Sewer Regulation Bylaw 1486 Consolidated](#)

[Subdivision Development Servicing Bylaw 1956 Consolidated](#)

[Sanitary Sewer Service Construction Guide](#)

[Sewer Information](#)

Master Municipal Construction Document (sample)

Arrange for an Inspection:

Once you have installed the building sewer line, please contact the **Building Inspections Department** at building@peachland.ca or (250) 767-2108 to arrange for an inspection. At least 48 hours notice should be given prior to an inspection.

- Pipe and connections are to be completely exposed and fully visible at time of inspection.
- Please have your property lines visible at time of inspection as well.

NOTE: Prior to backfilling the Sewer and Water service lines and the meter pit, Operations Department staff must be called for an inspection as well as the Building Inspector. The water service will NOT be turned on until a water meter is in place to the District's satisfaction.

Please note: Building Bulletins are prepared to provide convenient information for clients and should not be considered a replacement for reviewing the bylaw or associated legal documents. If there is any contradiction between this guide and relevant municipal bylaws and/or applicable codes, please refer to the bylaws and/or codes for legal authority.

Contact Information

District of Peachland

PLANNING AND DEVELOPMENT | 5806 Beach Ave Peachland BC V0H 1X7

BUILDING DEPARTMENT: PH 250 767 3709 Email: building@peachland.ca

OPERATIONS DEPARTMENT: PH 250 767 2108 Email: operations@peachland.ca